



Innovative use of Phase Change Materials (PCMs) for renewable heating & cooling

Adam Dicken

Info@pcmproducts.net

www.pcmproducts.net

What is Thermal Energy Storage?

“ Storing High or Low temperature energy for later use in order to bridge the time gap between energy availability and energy use ”

Bridging the gap



Types of Thermal Energy Storage

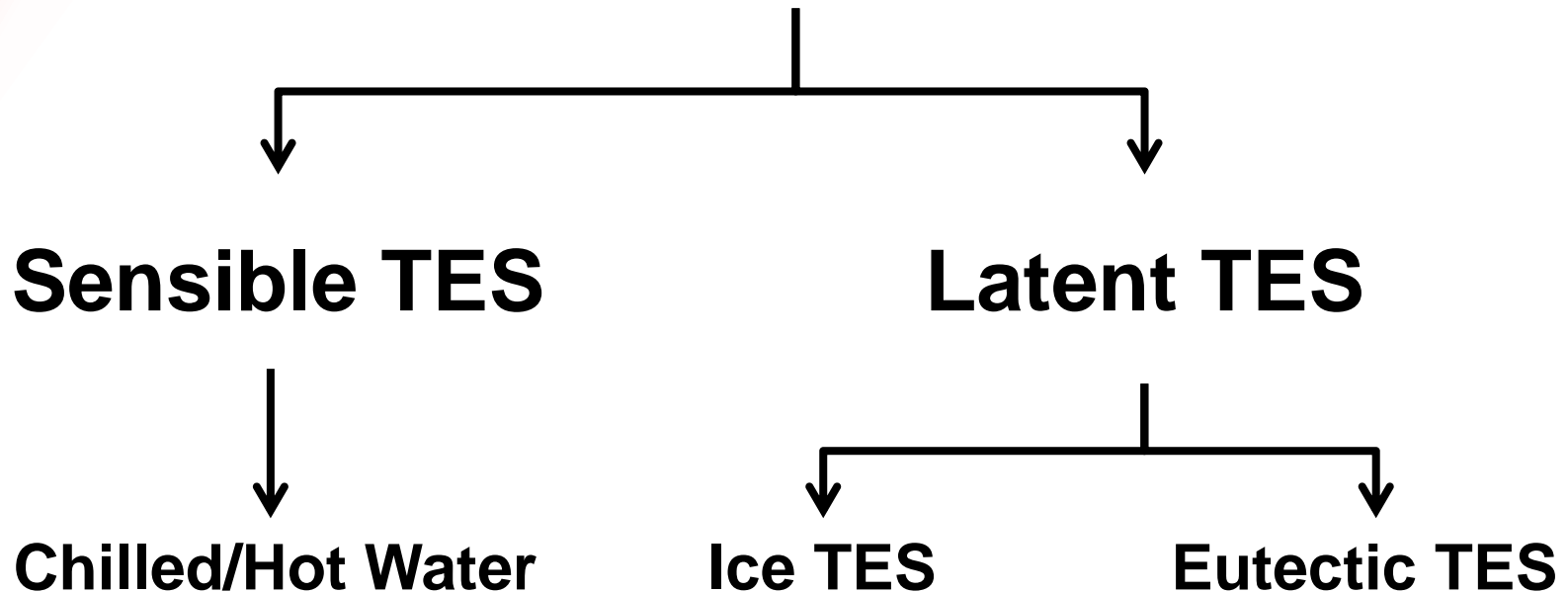

Sensible Heat vs Latent Heat

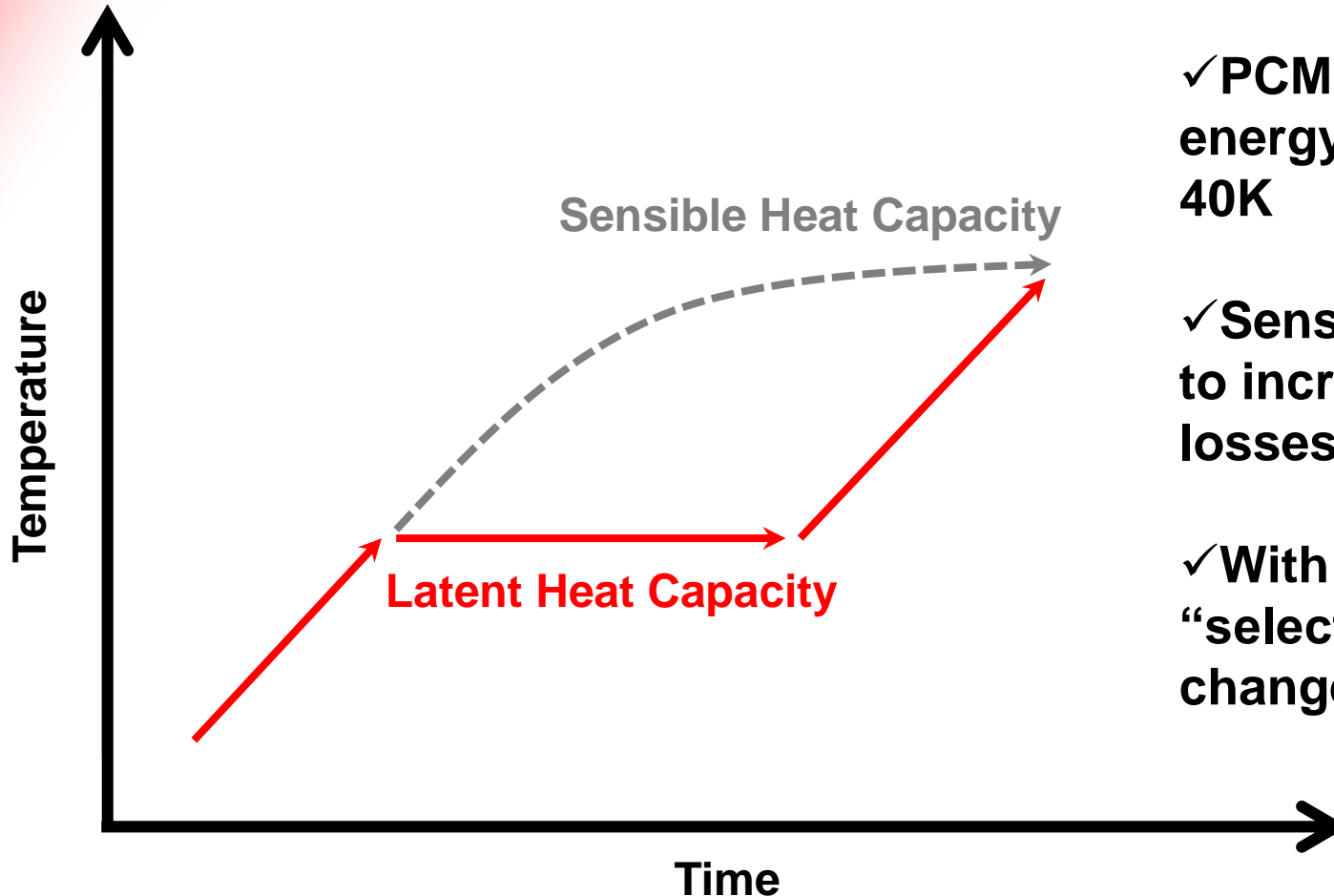

✓ PCM stores as much energy as a water ΔT of 40K

✓ Sensible heat leads to increased heat losses to surroundings

✓ With PCM you can "select" a phase change temperature

Eutectic Material Phase Change Material (PCM)

Eutectic – “Mixture of two or more chemicals (inorganic salts) having a freezing / melting temperature point which is higher or lower than those of water 0°C (32°F).”

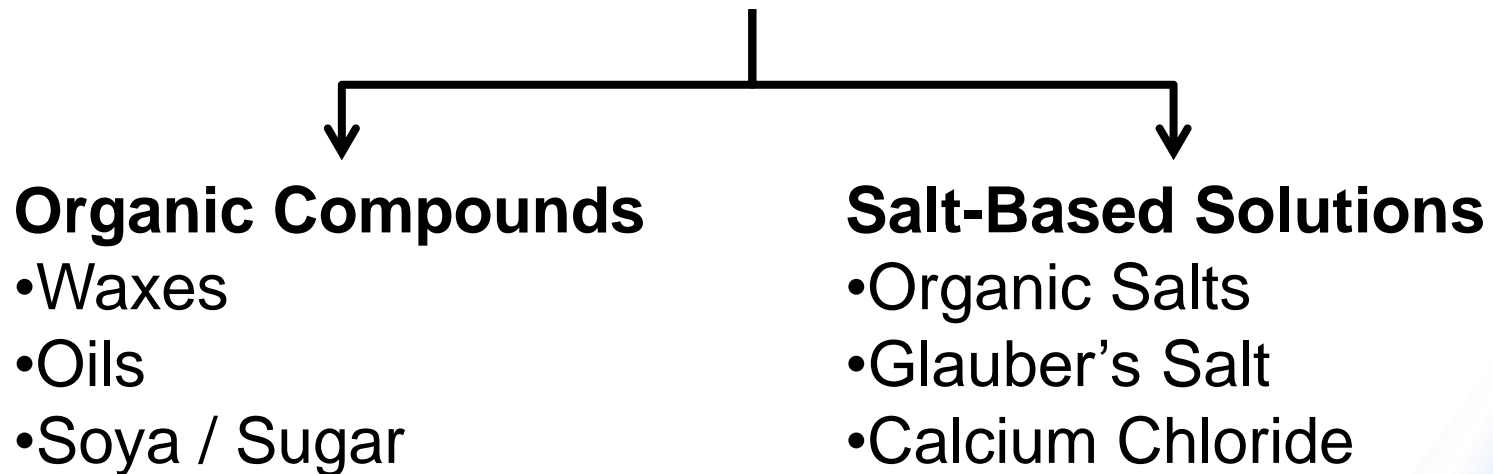

0°C

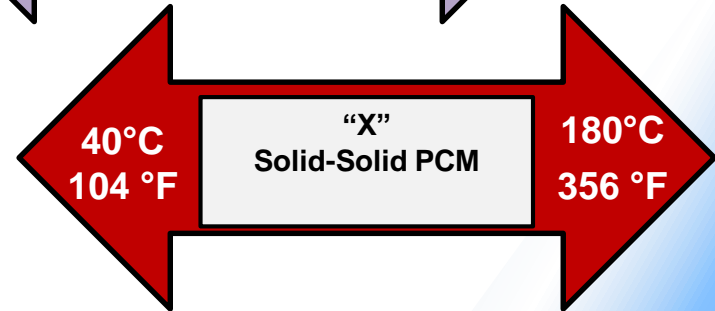
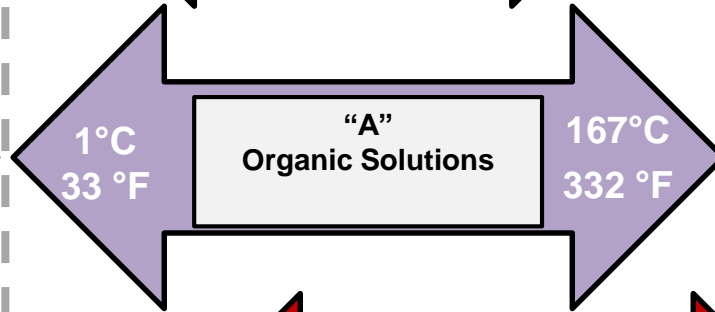
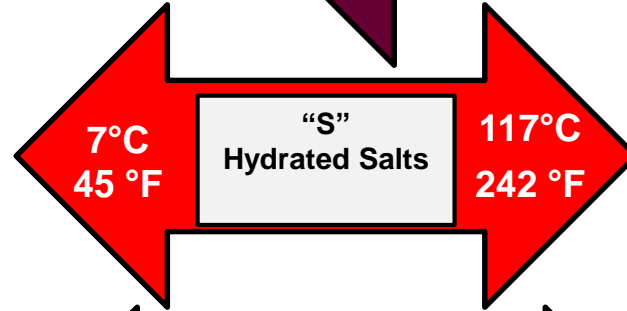
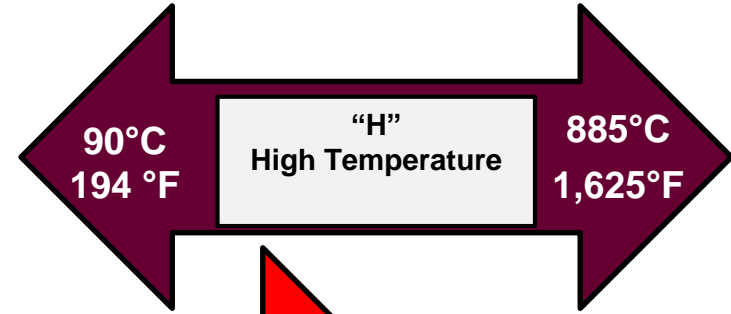

Solid Plastic Encapsulated PCM



Metal Encapsulated PCM

Metal Containers



Tubes



Balls



Tiles



Flexible Encapsulated PCM

Pouches

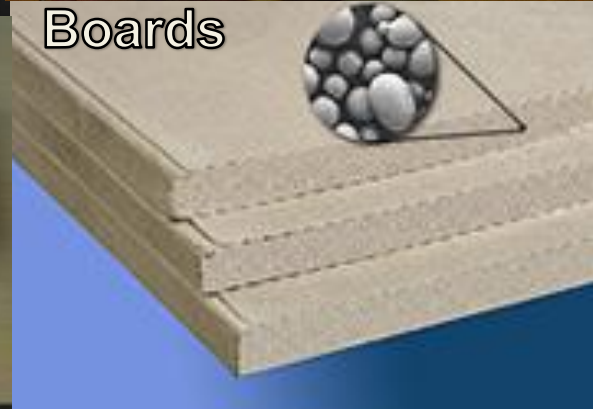

Free Energy

“Bridging the gap”

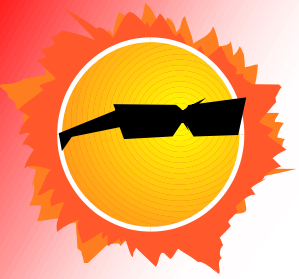

Solar Applications

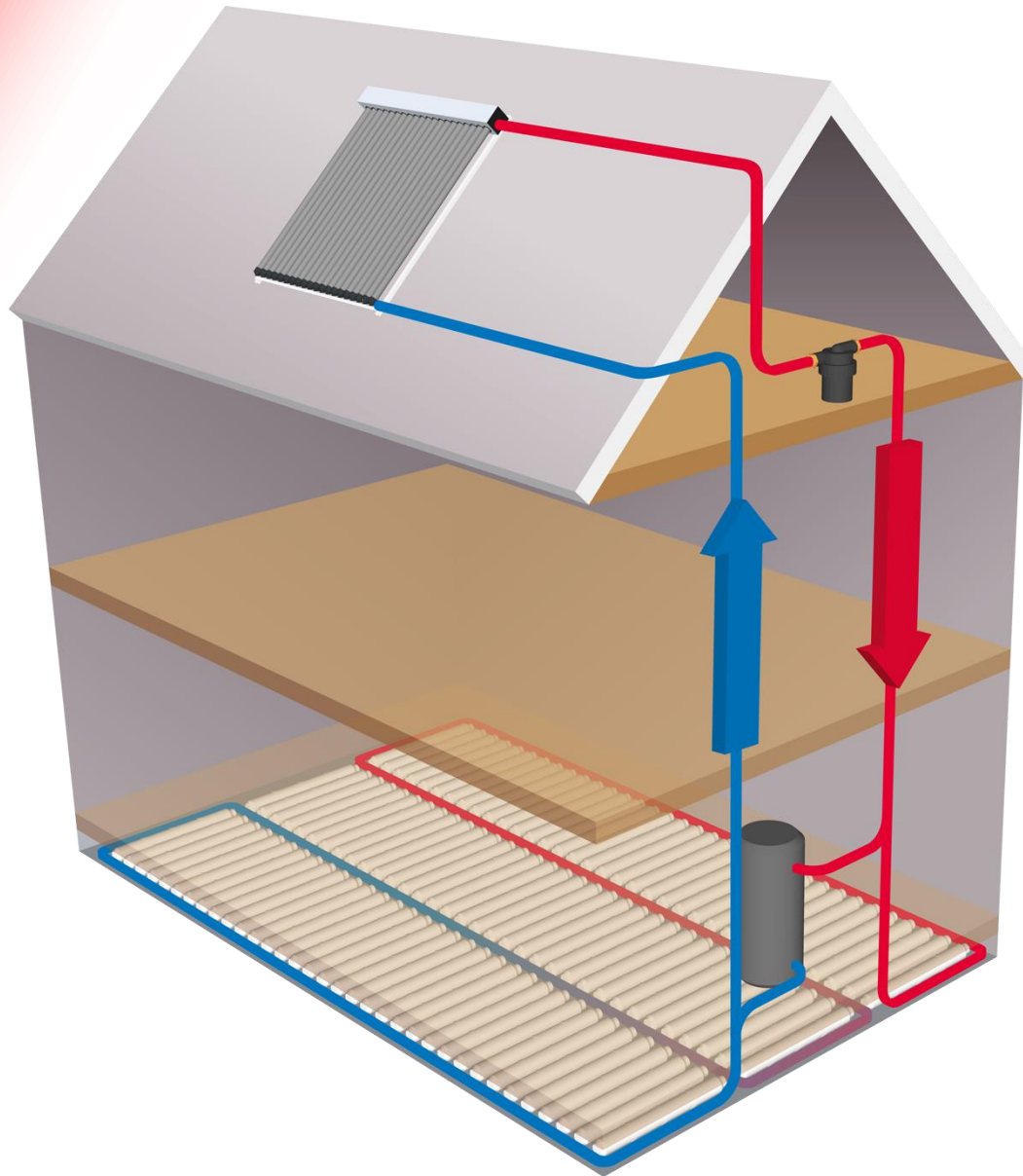

Commonwealth Village, Australia

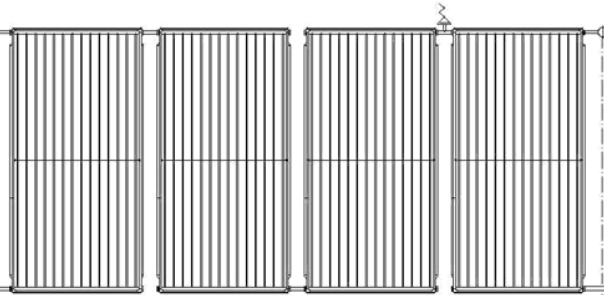

SOLAR PANELS.

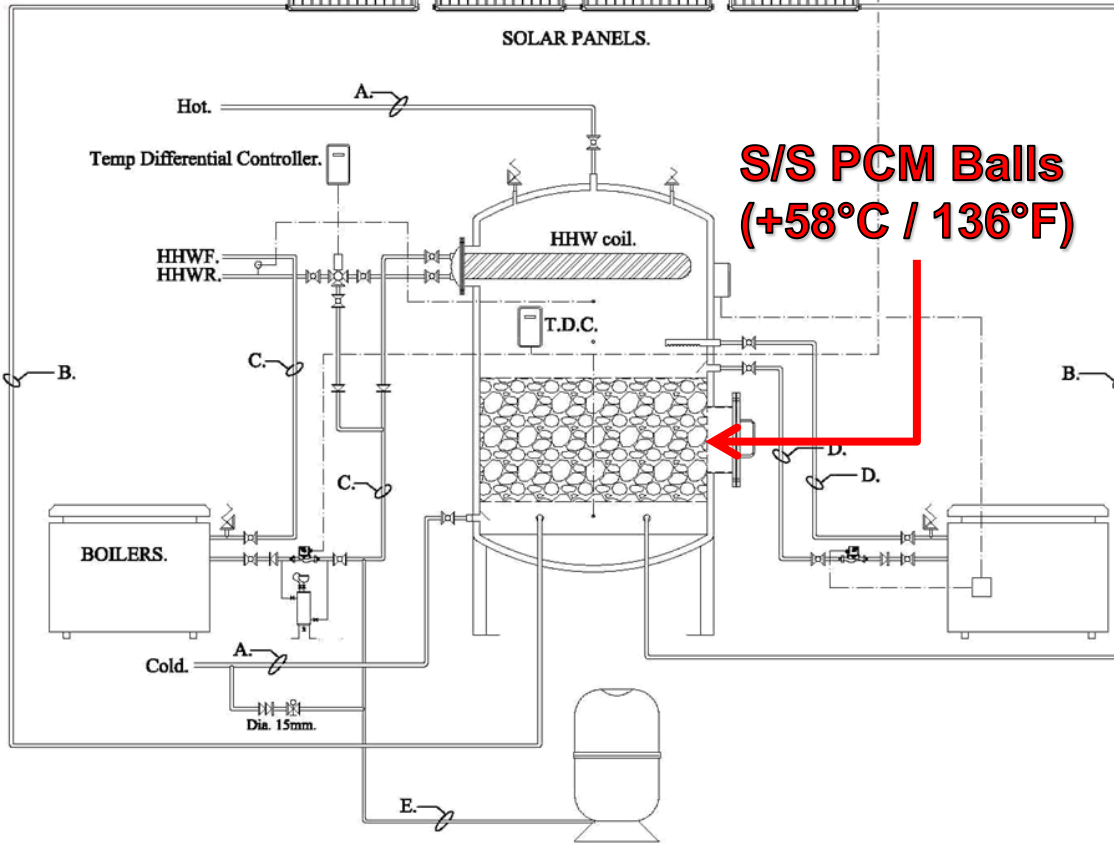

LEGEND.

- ⊠ Gate Valve.
- ⊠⊠ RPZD/Dual Check.
- ⊠ Ball Valve.
- ⊠ Pressure relief valve.
- ⊠ Automatic Air-Vent.
- ⊠ Check Valve / Non-Return.
- ⊠ Balancing Valve.
- ⊠ Automatic Filling Valve.
- ⊠ Gas Valve.



00 R/E/1, 1/2007 Commonwealth Games

Total Water Management Solutions

ABN. 42 070 348 008

104 Cubitt Street, Richmond, Victoria 3121
Telephone (03) 8430-3013 Fax/Inile (03) 8429-3714
E-mail: twnm@twmsol.com

Total Water Management Solutions shall be the sole owner of this Drawing. No data herein may be copied by any means, nor any depicted item made without prior approval from Total Water Management Solutions.

Designed	N.Viele
Drawn	NV
Checked	
Approved	

Job.

Commonwealth Games.

Title

Typical Hot Water Schematic.

Scale

Drawing No.

Passive Cooling



NIGHT (+21°C / 69°F)



DAY (+35°C / 95°F)

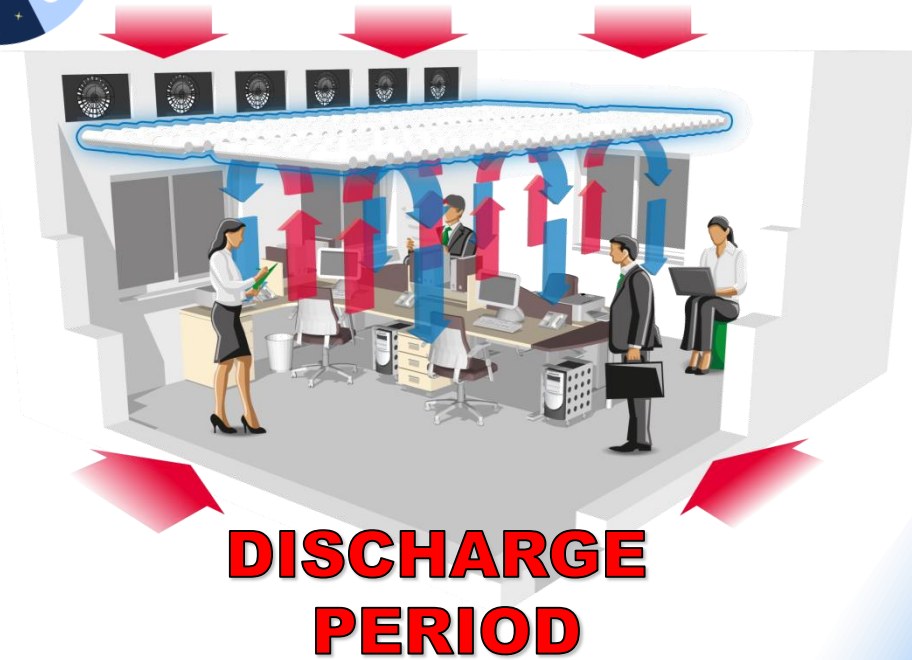
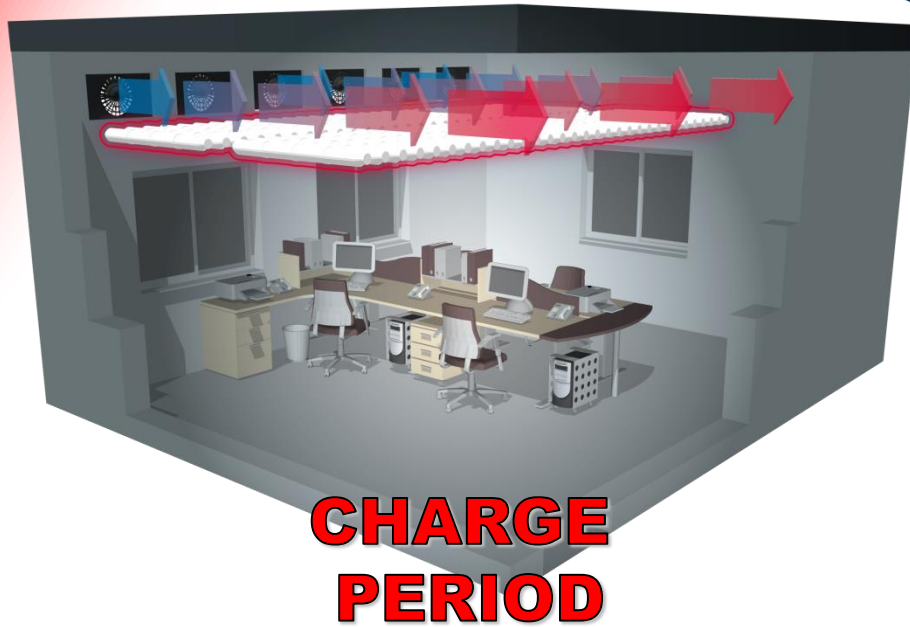

Passive Cooling



NIGHT (+21°C / 69°F)



DAY (+55°C / 131°F)

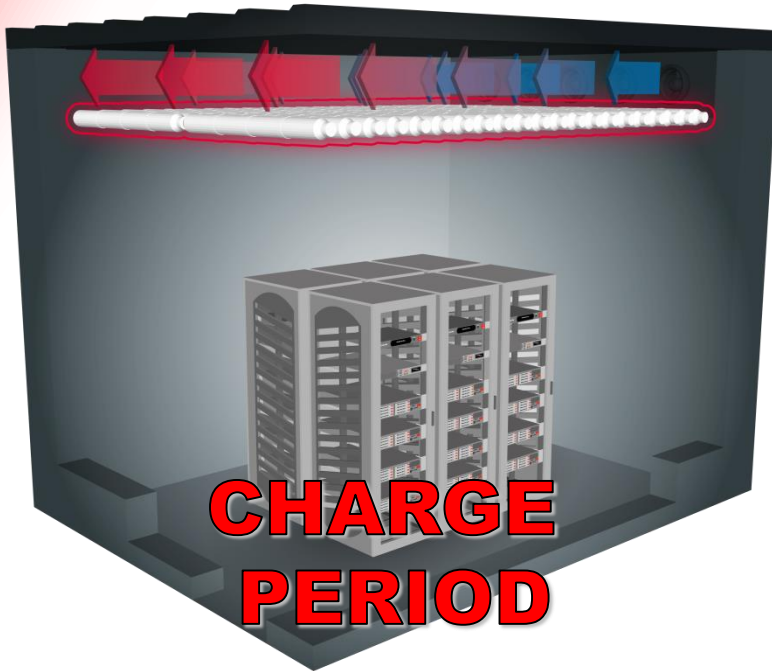

ROOM (+45°C / 113°F) MAX

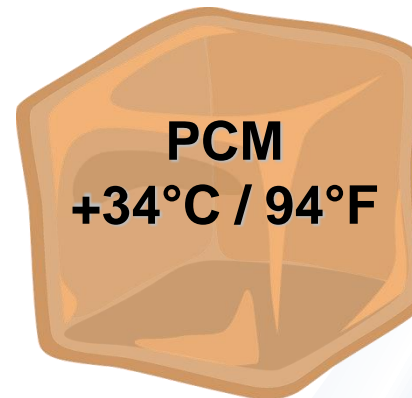
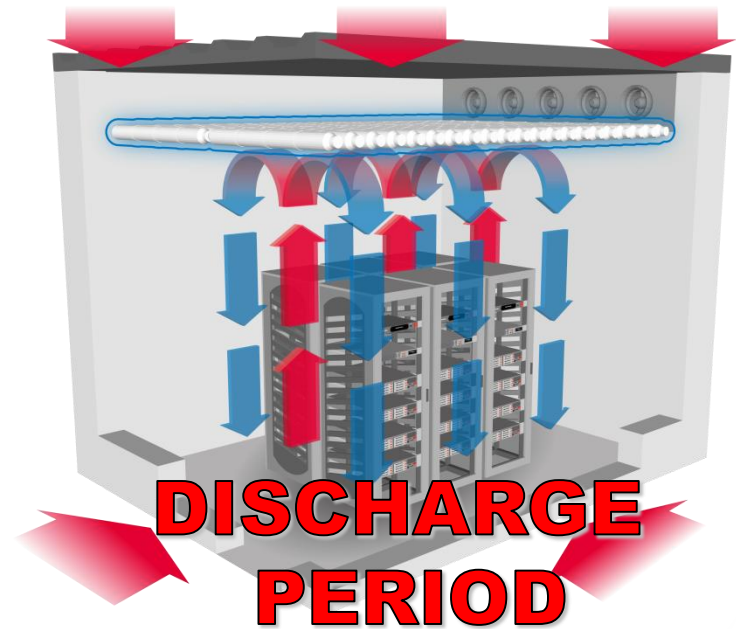

Free Cooling



Psychrometric Chart

SI (metric) units
Barometric Pressure 101.325 kPa (Sea level)
based on data from
Carrier Corporation Cat. No. 794-001, dated 1975

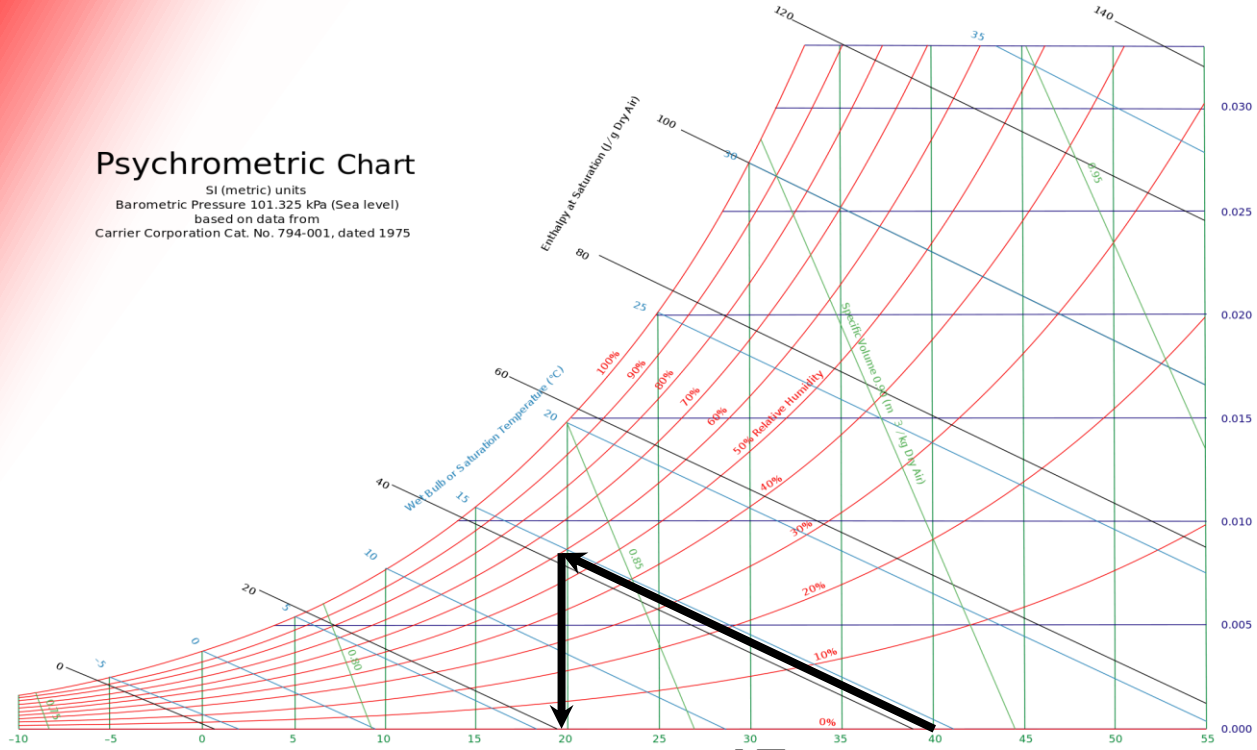

Wet Bulb ← ΔT → **Dry Bulb**



Free Cooling

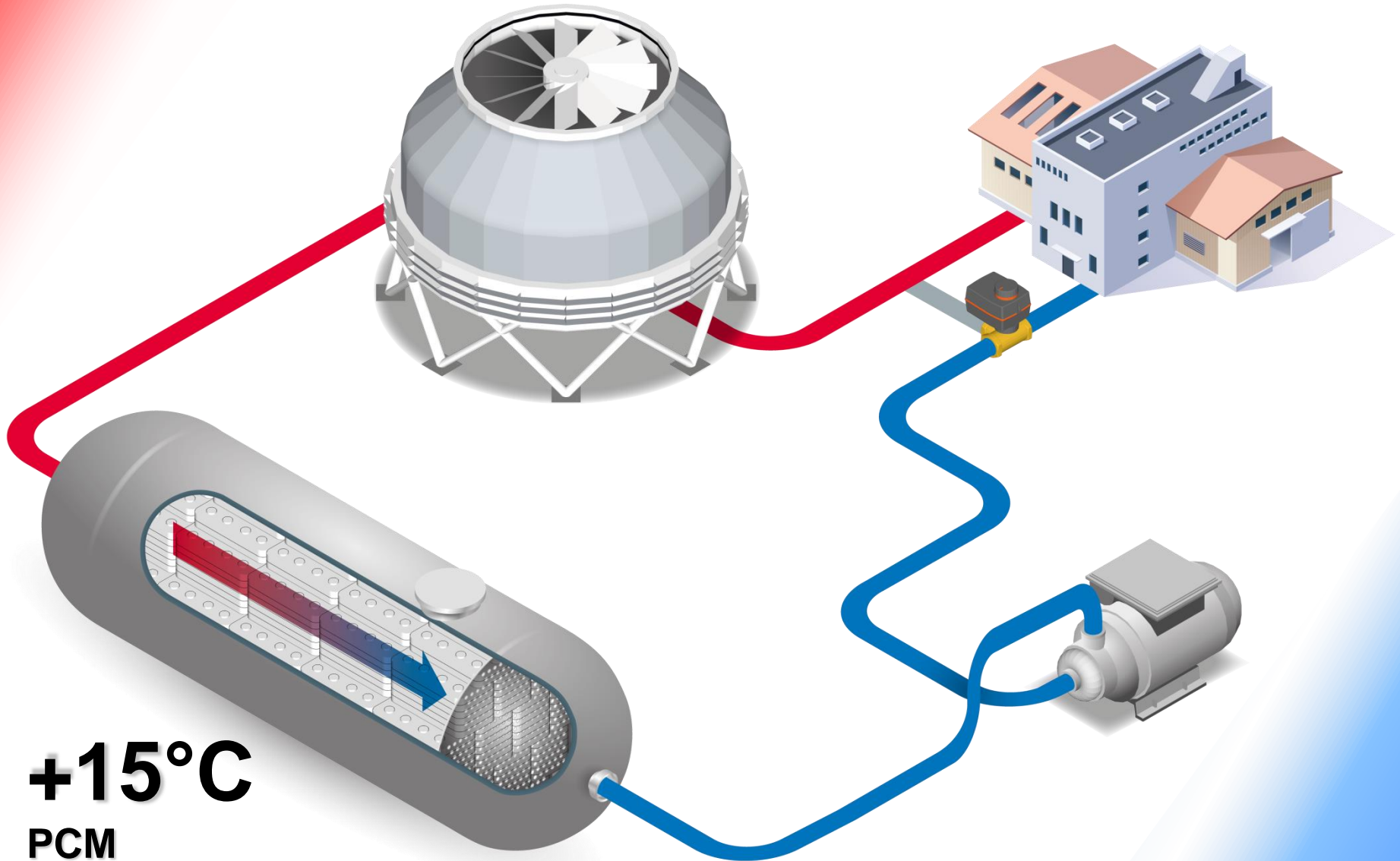

+15°C
PCM
Energy Storage

Melbourne City Council Office, Australia

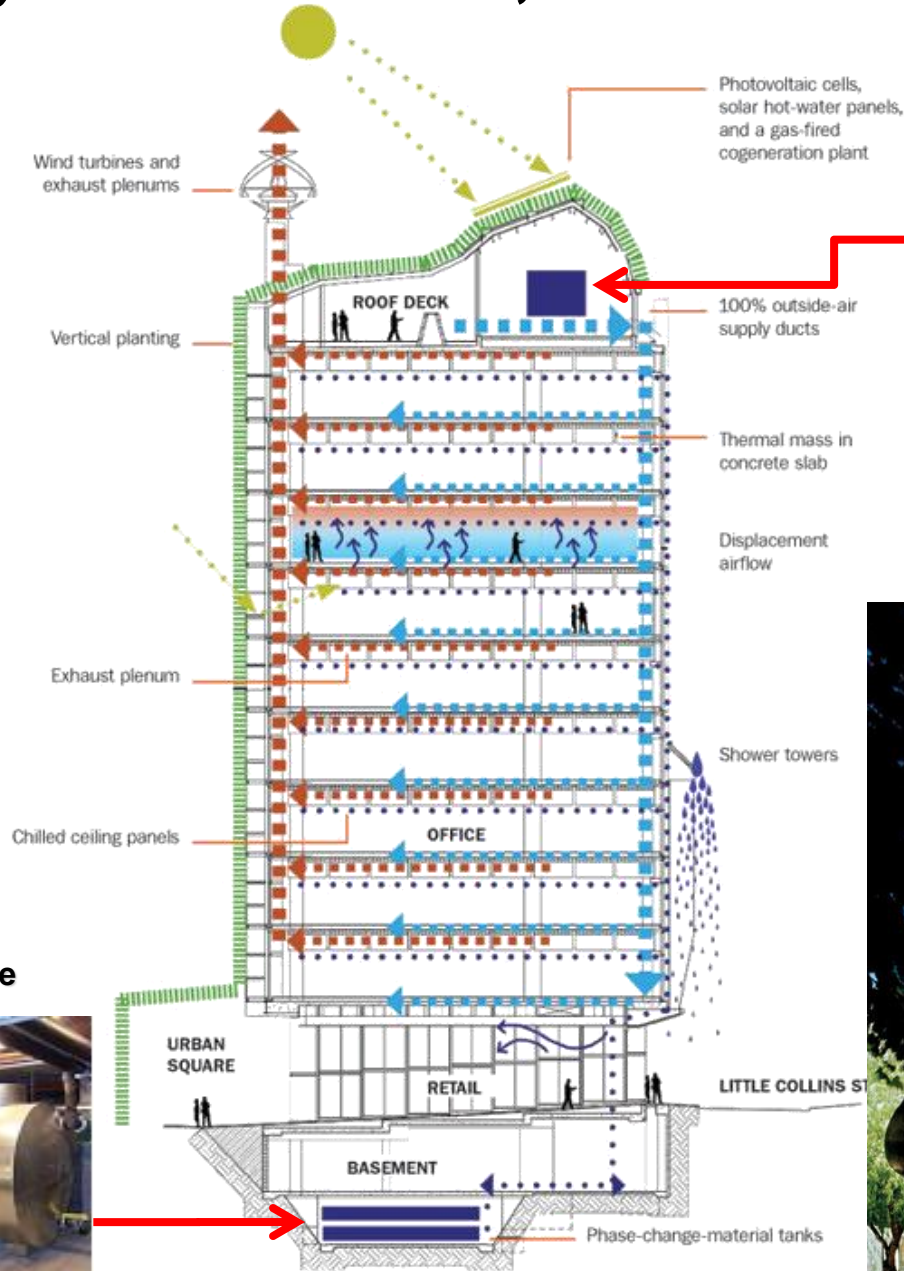

+15°C
PCM
Energy Storage



Heat Pump System

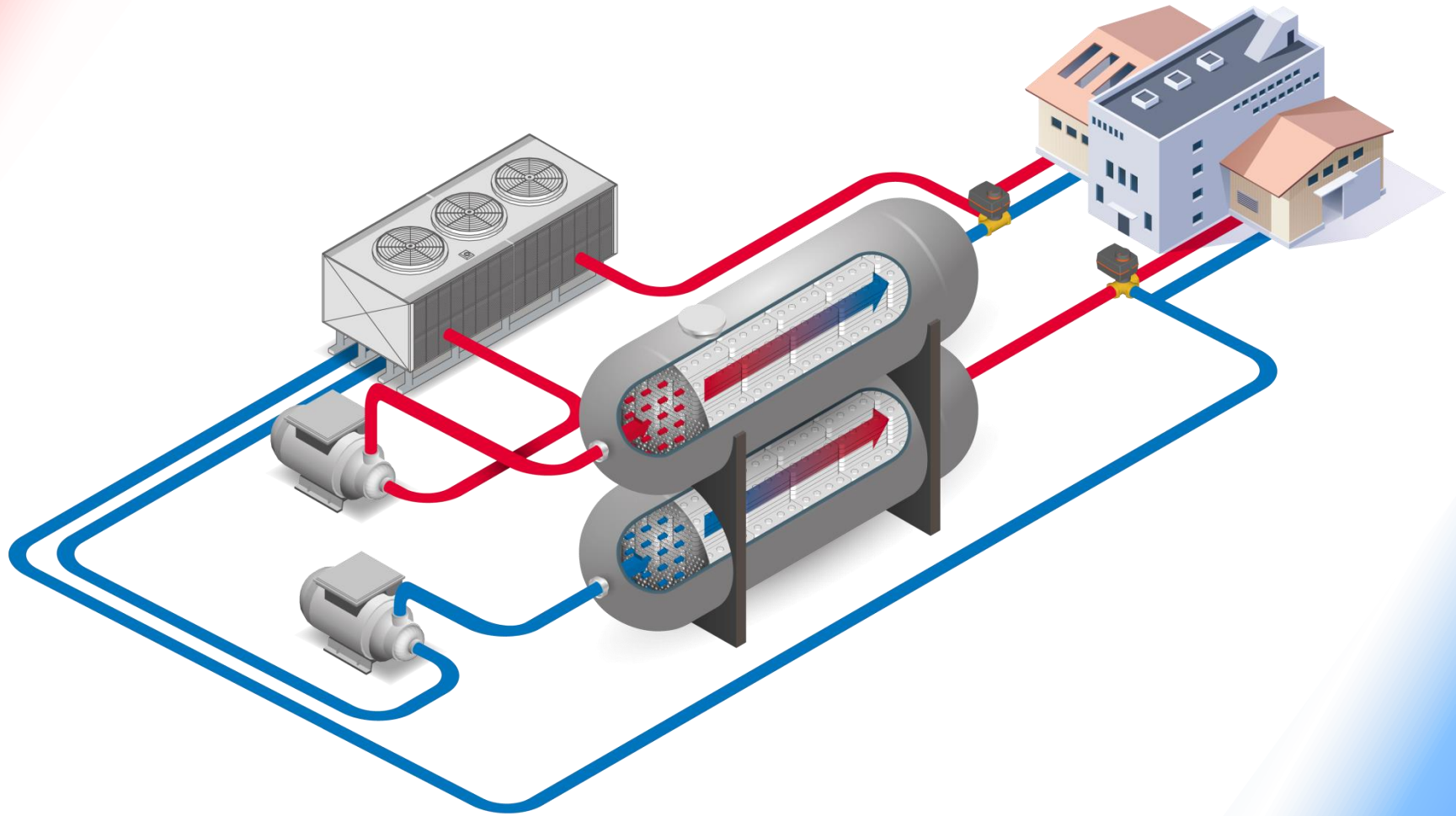

Heat & Coolth Stored

EIDOS, Turin, Italy

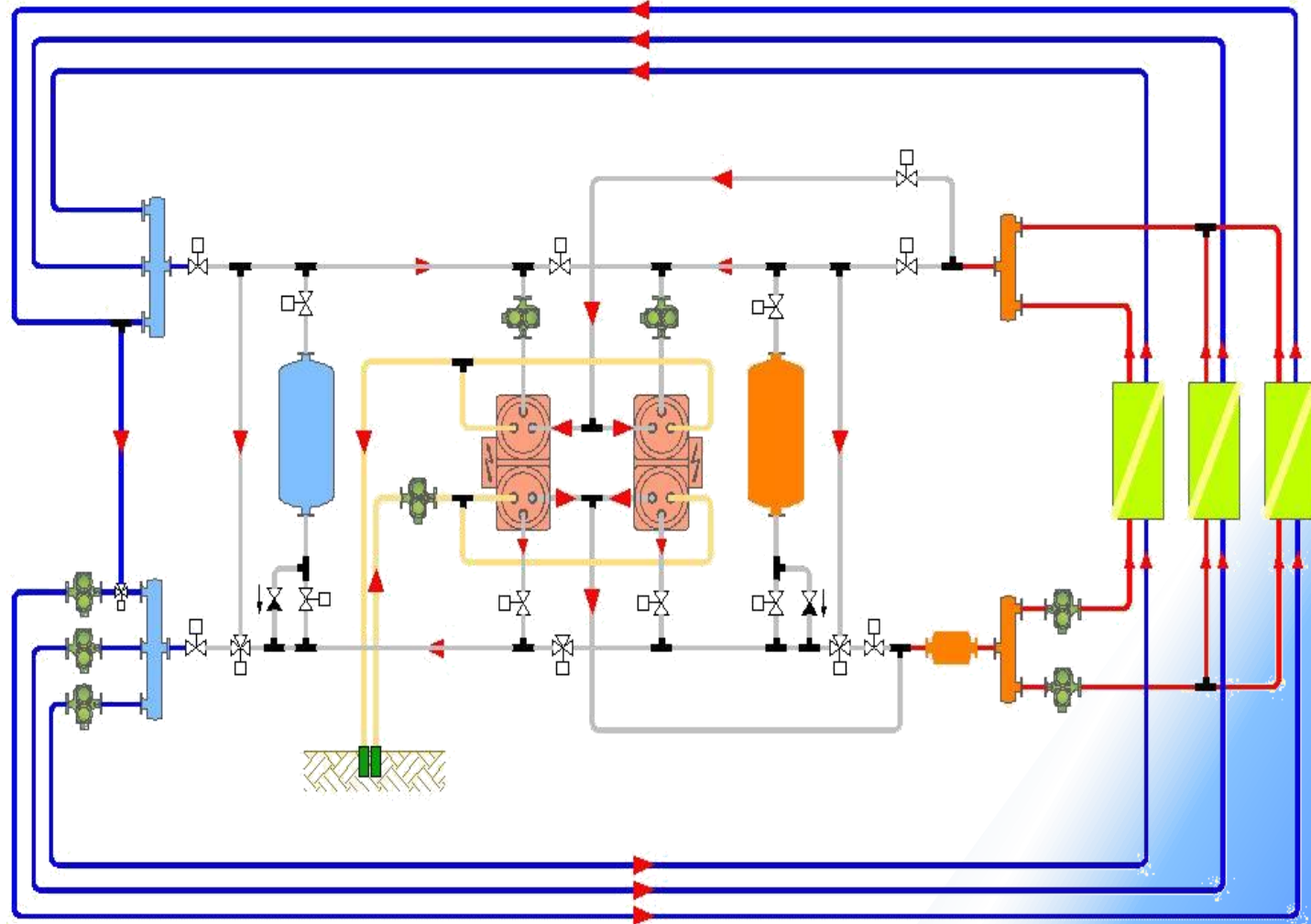
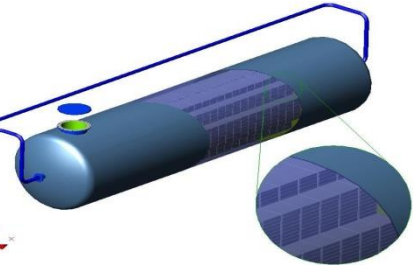
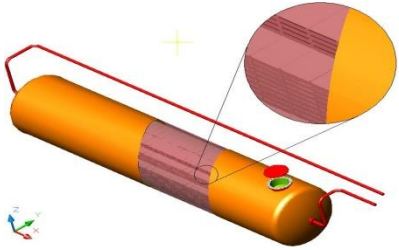
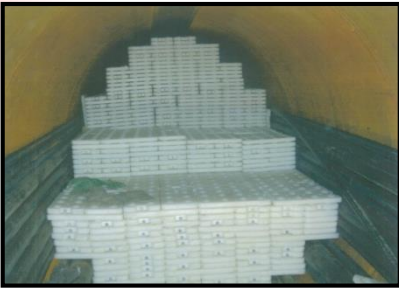

Load Shifting

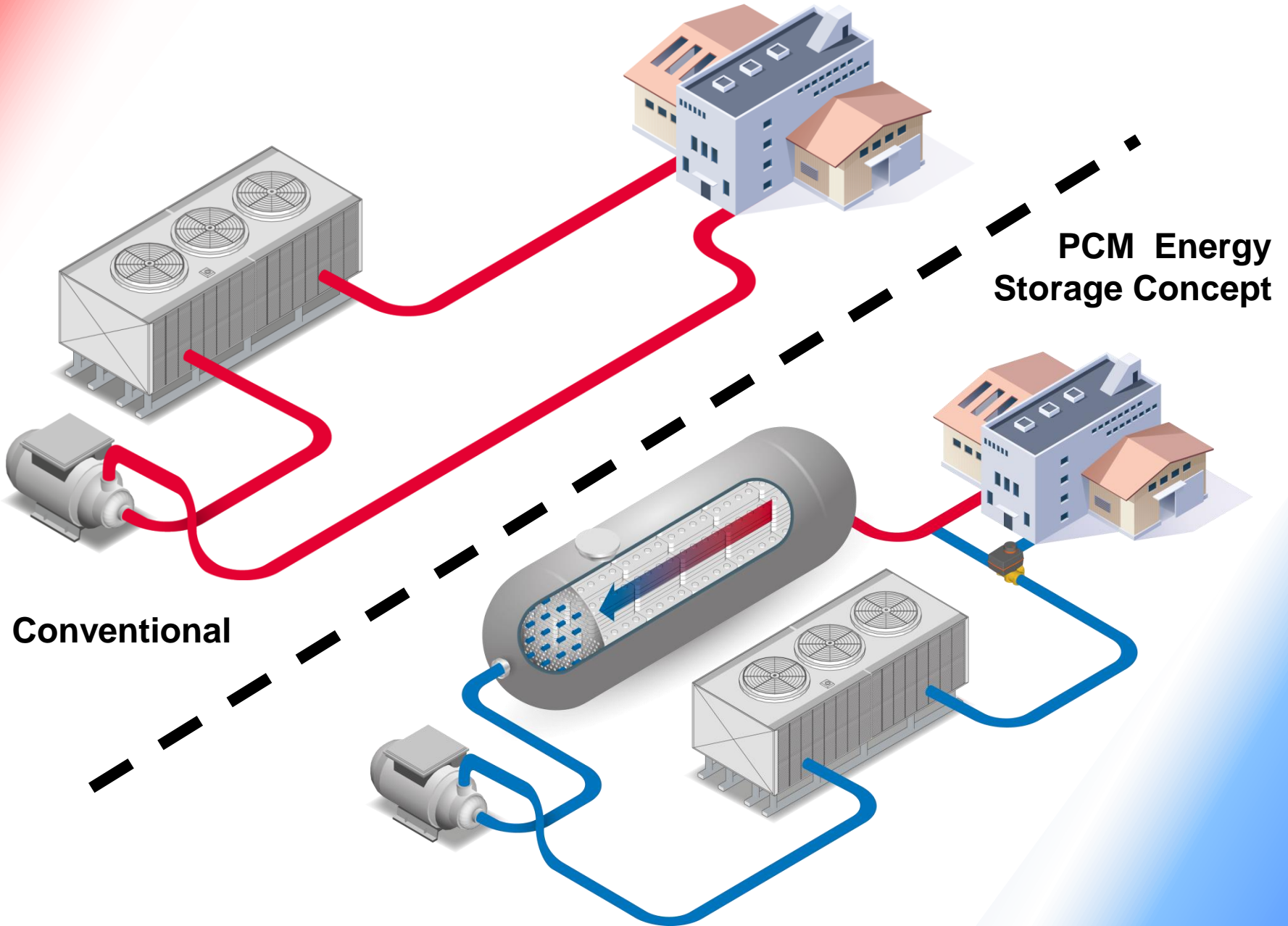



PCM

Thermal Energy Storage

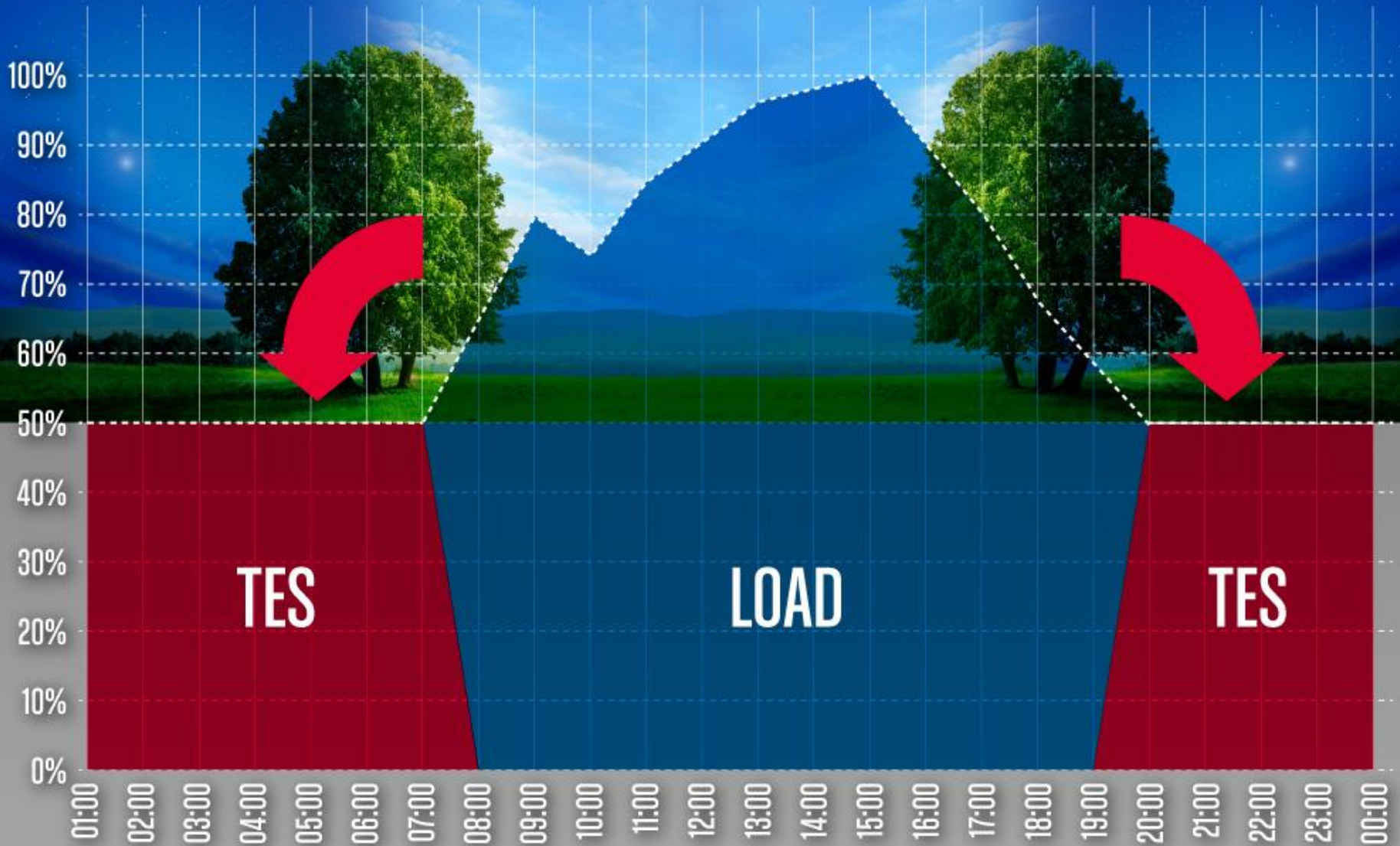

T3 Energy Centre, Bergen Airport, NOR



**4 x 60m³ Tanks
filled with S13
(+13°C/55°F)**

**Total Capacity
10,000kWh
(2,840 RT-h)**

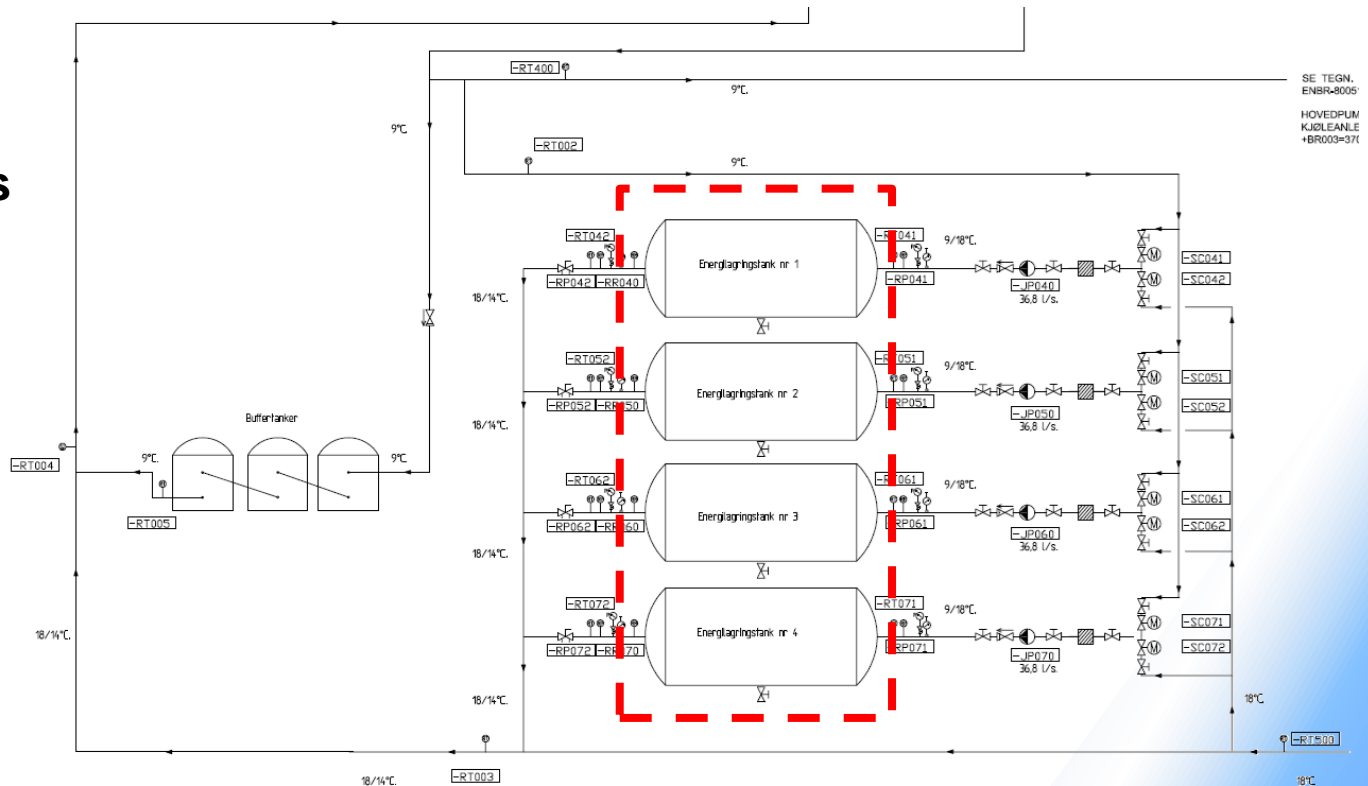

Parliament House, Canberra, AUS.



6m³ Tank filled with +8°C PCM solution providing 270kWh TES for backup



Conclusion



- **FREE** (Day=Heat / Night=Cool) energy.
- **WASTE** not (Heat or Cold Energy).
- Load shifting/levelling.
- Consider mix of matching technologies.
- Never Forget RoI - *Someone has to pay for your idea.*
- **RIGHT** technology for **RIGHT** application.

Follow Up



Adam Dicken

adam.dicken@pcmproducts.net

www.pcmproducts.net

info@pcmproducts.net